

WHEATON®

VIAL GUIDE



**DURAN
WHEATON
KIMBLE**

Excellence in your hands



WHEATON® Vials

Vials

WHEATON offers the most comprehensive line of ampules, vials and accessories for the laboratory research market. Sample vials, fabricated from high-quality glass tubing, offer uniform sidewall and bottom thickness. Liquid scintillation vials are the original scintillation vials invented by WHEATON over 60 years ago. Manufactured from low potassium borosilicate glass, PET and HPDE, the WHEATON line of vials is the largest and most diverse in the industry. High recovery vials feature a conical interior that allows for maximum retrieval of a sample with a syringe. Certain vial styles can be used with automated compound storage systems and easily bar coded using a 2D or linear bar code format. WHEATON CryoELITE® Cryogenic Vials offer unrivaled capseals that exceed DOT and IATA regulations.

When you are looking for a high-quality and dependable vial, WHEATON can provide the best product for your application. WHEATON can also accommodate the custom design and manufacturing of vials. Additionally we offer bar coding, critical cleaning, and surface treatment services.

About WHEATON®

WHEATON admires those people who devote their life to science. It's this admiration that drives us to design and deliver today's most innovative solutions for the laboratory research, diagnostic packaging and specialty pharmaceuticals industries. It's this admiration that motivates us to offer the best customer service experience and most dependable products in the industry. And, it's with admiration that we stand behind those people who help move the world forward one discovery, one sample at a time. The WHEATON name means more than a legacy of the highest quality products and services; it stands for a commitment to honor the effort of all scientists... WHEATON is the proven solutions for science.

Table of Contents

> Crimpers & Decappers	20
> Cryogenic Vials	24
> EPA Vials.....	18
> E-Z Ex-Traction® Vials.....	17
> Freezer Boxes	26
> Liquid Scintillation Vials.....	4
> MicroTubes	25
> Racks	22
> Sample Vials.....	7
> Seals & Stoppers.....	12-13
> Scanners.....	27
> Screw Caps	10
> Serum Vials & Bottles.....	11
> Sizer Guides.....	6, 28-29
> Specialty Vials.....	18
> Uni-Dose Bottle & Vials.....	19
> Vacule®.....	11
> Vial File®.....	8, 22
> V-Vials®	15



Top Vial Selections

Liquid Scintillation

- Made from WHEATON 180 low potassium borosilicate glass that conforms to USP Type I and ASTM E 438 Type I, Class A requirements
- Background counts are consistent and low, ultraviolet transmission is high
- Screw caps can be purchased separately



Sample Vial

- Clear vials conform to USP Type I and ASTM E 438 Type I, Class A requirements
- Amber vials made from borosilicate glass that conforms to USP Type I requirements for light transmission to protect light-sensitive products
- Lab File® with partitioned trays provides an easy way to inventory samples or to store empty vials



Serum Vials

- Clear vials manufactured from low extractable borosilicate glass that conforms to USP Type I and ASTM E 438 Type I, Class A requirements
- Amber glass conforms to USP Type I requirements to protect light-sensitive samples
- Tubular design provides excellent clarity and dimensional consistency from vial to vial



High Recovery V-Vials

- Conical interior provides downward drainage for maximum sample retrieval
- Ideal for small-scale reactions, centrifugation, storage, packaging and shipping
- Low particulate packaging protects against contamination during transportation and storage

CryoELITE Vial

- Lot certified RNase / DNase and endotoxin free and non-pyrogenic providing assurance for sample integrity
- Unrivaled cap seal exceeds DOT and IATA regulations ensuring ultimate protection of samples during transportation and demanding freeze-thaw handling
- Freestanding and round bottom styles available



Select from Glass, HDPE and PET Vials

- Packaged in 5 utility trays with each partition tray holding 100 vials
- Utility trays serve as a way to store your samples
- For additional organization of your vials, use the WHEATON Vial Rack 868806 or M-T Vial File® W228792
- Cases with 1000 vials are packed in a single plastic bag with caps in a separate bag

Glass

- Made from WHEATON 180 low potassium borosilicate glass that conforms to USP Type I and ASTM E 438 Type I, Class A requirements
- Background counts are consistent and low, ultraviolet transmission is high

Cap Liner Guide

Liner Material	Description	Applications
Foamed Polyethylene (PE Foam)	A one piece, three ply coextruded liner consisting of both foamed and solid LDPE. The foam core is sandwiched with solid clear PE.	General Purpose: Broad applications base. Good chemical resistance to acids, alkalis, solvents, alcohols, oils, household cosmetics and aqueous products. Poor for hydrocarbon solvents. Liner provides tight seal.
Pulp / Metal Foil	Aluminum foil bonded to pulp board.	Good barrier properties and resistance to hydrocarbons, oils, ketones and alcohols. Not good for acids or alkalis.
Polyethylene Cone (PE Cone)	Manufactured from polyethylene (LDPE). The unique cone design provides a wedge type seal that not only seals across the top but also across the inside diameter.	Unique problem solving type of liner. This liner is stress crack resistant and offers superior torque retention and excellent sealing characteristics. It is recommended that this liner be tested prior to use for leak seal.

Note: Closures and liners are designed for a variety of applications. Product performance can vary depending on conditions. It is recommended that proper tests be performed to determine the best liner for the application.

HDPE

- Made from high density polyethylene with lightweight walls for increased counting efficiency
- Manufactured to precise tolerances to avoid jamming

PET

- Vials offer low permeability to solvents and minimal background counts
- Clarity of glass with the safety of plastic
- Vials can be safely incinerated; no harmful gas is generated



Liquid Scintillation Vials

Cat. No.	Size (mL)	Vial Material	Cap Material	Liner Material	Cap Size	Dia. x H (mm)*	Qty / Case
Caps Attached to Vials							
986540	20	Glass	Polypropylene	Foamed Polyethylene	22-400	28 x 61	500
986541	20	Glass	Polypropylene	Metal Foil / Pulp	22-400	28 x 61	500
986542	20	Glass	Urea	Metal Foil / Cork	22-400	28 x 61	500
986546	20	Glass	Urea	Polyethylene Cone	22-400	28 x 61	500
986548	20	Glass	Urea	Polyethylene Disc	22-400	28 x 61	500
986560	20	Glass	Polypropylene	Foamed Polyethylene	24-400	28 x 61	500
986561	20	Glass	Polypropylene	Metal Foil / Pulp	24-400	28 x 61	500
986562	20	Glass	Urea	Metal Foil / Cork	24-400	28 x 61	500
986568	20	Glass	Urea	Polyethylene Disc	24-400	28 x 61	500
986700	20	HDPE	Polypropylene	Foamed Polyethylene	22-400	27 x 61	500
986701	20	HDPE	Polypropylene	Metal Foil / Pulp	22-400	27 x 61	500
986702	20	HDPE	Urea	Metal Foil / Cork	22-400	27 x 61	500
986704	20	HDPE	Polyethylene	Linerless	22-400	27 x 61	500
986706	20	HDPE	Urea	Polyethylene Cone	22-400	27 x 61	500
986730	20	PET	Polypropylene	Foamed Polyethylene	22-400	27 x 61	500
986731	20	PET	Polypropylene	Metal Foil / Pulp	22-400	27 x 61	500
986732	20	PET	Urea	Metal Foil / Cork	22-400	27 x 61	500
986734	20	PET	Polyethylene	Linerless	22-400	27 x 61	500
986736	20	PET	Urea	Polyethylene Cone	22-400	27 x 61	500
Caps Packaged Separately							
986580	20	Glass	Polypropylene	Foamed Polyethylene	22-400	28 x 61	500
986581	20	Glass	Polypropylene	Metal Foil / Pulp	22-400	28 x 61	500
986582	20	Glass	Urea	Metal Foil / Cork	22-400	28 x 61	500
986586	20	Glass	Urea	Polyethylene Cone	22-400	28 x 61	500
986590	20	Glass	Polypropylene	Foamed Polyethylene	24-400	28 x 61	500
986591	20	Glass	Polypropylene	Metal Foil / Pulp	24-400	28 x 61	500
986710	20	HDPE	Polypropylene	Foamed Polyethylene	22-400	27 x 61	500
986720	20	HDPE	Polypropylene	Foamed Polyethylene	22-400	27 x 61	1000
986711	20	HDPE	Polypropylene	Metal Foil / Pulp	22-400	27 x 61	500
986721	20	HDPE	Polypropylene	Metal Foil / Pulp	22-400	27 x 61	1000
986714	20	HDPE	Polyethylene	Linerless	22-400	27 x 61	500
986724	20	HDPE	Polyethylene	Linerless	22-400	27 x 61	1000
986722	20	HDPE	Urea	Metal Foil / Cork	22-400	27 x 61	1000
986716	20	HDPE	Urea	Polyethylene Cone	22-400	27 x 61	500
986726	20	HDPE	Urea	Polyethylene Cone	22-400	27 x 61	1000
986750	20	PET	Polypropylene	Foamed Polyethylene	22-400	27 x 61	500
986740	20	PET	Polypropylene	Foamed Polyethylene	22-400	27 x 61	1000
986751	20	PET	Polypropylene	Metal Foil / Pulp	22-400	27 x 61	500
986741	20	PET	Polypropylene	Metal Foil / Pulp	22-400	27 x 61	1000
986754	20	PET	Polyethylene	Linerless	22-400	27 x 61	500
986744	20	PET	Polyethylene	Linerless	22-400	27 x 61	1000
986752	20	PET	Urea	Metal Foil / Cork	22-400	27 x 61	500
986742	20	PET	Urea	Metal Foil / Cork	22-400	27 x 61	1000
986756	20	PET	Urea	Polyethylene Cone	22-400	27 x 61	500
986746	20	PET	Urea	Polyethylene Cone	22-400	27 x 61	1000

*Measurement taken with cap attached.

Liquid Scintillation Vial

(Without Screw Caps)

- Made from WHEATON 180 low potassium borosilicate glass that conforms to USP Type I and ASTM E 438 Type I, Class A requirements
- Background counts are consistent and low, ultraviolet transmission is high
- Screw caps can be purchased separately
- Packaged in 5 utility trays with each partitioned tray holding 100 vials each
- Utility trays serve as a way to store your samples
- For additional organization of your vials use the WHEATON Vial Rack 868806 or M-T Vial File® W228792



Cat. No.	Size (mL)	Vial Material	Cap Size	Dia. x H (mm)	Qty / Case
986532	20	Glass	22-400	28 x 57	500

Liquid Scintillation Vial Screw Caps

- Screw caps for WHEATON liquid scintillation vials
- Use as replacement caps or for vials that are provided without caps
- Choose the right size screw cap for your vial
- Select cap and liner material for your application
- Not autoclavable



Cat. No.	Cap Size (mm)	Cap Material	Cap Liner Material	Qty / Case
241009	15-425	Urea	Metal Foil	1000
240804	22-400	Polypropylene	Metal Foil	1000
241017	22-400	Urea	Metal Foil	1000
240817	22-400	Urea	Polyethylene Disc	1000
240917	22-400	Urea	PE Cone	1000
241317	22-400	Polyethylene	Linerless	1000
240805	24-400	Polypropylene	Foil / Pulp	1000
241018	24-400	Urea	Metal Foil	1000
240818	24-400	Urea	Polyethylene Disc	1000

Scintillation Vial, HDPE



Quarter Turn Cap Quarter Turn Hanging Cap Hanging Cap Sample with 20mL Vial

- 6mL vial made from high density polyethylene
- Hanging cap allows for suspending vial in 20mL vial with 22mm neck finish
- Dimensions with cap attached: 17mm x 57mm
- For additional organization of your vials use the WHEATON Vial Rack 868810
- Linerless polypropylene cap

Cat. No.	Size (mL)	Cap Type	Qty / Case
225414	6	Quarter Turn	1000
225415	6	Quarter Turn Hanging Style	1000

Diagnostic Vials

- Borosilicate glass meets USP Type I
- Alternative to serum bottles and vials
- Screw thread design eliminates need for crimping tools
- Ideal for lyophilization
- Fits with I-Loc™ closure or screw cap with thin flange stopper
- Tubular design provides excellent clarity and dimensional consistency from vial to vial
- Heavy walled glass provides impact resistance



Cat No.	Color	Size (mL)	Dia. x H (mm)	Cap Size	Qty / Case
W219365	Clear	5	22 x 38	20-400	480
W216375	Amber	5	22 x 38	20-400	480
W219366	Clear	10	22 x 55	20-400	480
W216376	Amber	10	22 x 55	20-400	480
W216377	Amber	20	30 x 52	20-400	480
W219368	Clear	30	30 x 69	20-400	288
W216378	Amber	30	30 x 69	20-400	288

I-Loc™ Closure

- For use with Screw Neck Diagnostic Vials
- Advantages of an aluminum seal with the convenience of a screw cap
- Polypropylene screw cap with gray bromobutyl / 50 stopper
- Autoclavable



Cat. No.	Color	Cap Size	Qty / Case
240676-01	Black	20-400	100
240676-02	White	20-400	100
240676-03	Red	20-400	100
240676-04	Blue	20-400	100
240676-05	Yellow	20-400	100

Screw Caps for Screw Neck Diagnostic Vials



- Polypropylene screw caps in 5 colors
- Use with 224100-203 or W224100-195 thin flange stopper
- Autoclavable

Cat. No.	Cap Size	Cap Style	Color	Autoclavable	Qty / Case
240706-01	20-400	Solid Top	Black	Yes	300
240706-02	20-400	Solid Top	White	Yes	300
240706-04	20-400	Solid Top	Blue	Yes	300
240706-05	20-400	Solid Top	Yellow	Yes	300
240716-01	20-400	Open-Top	Black	Yes	300
240716-02	20-400	Open-Top	White	Yes	300
240716-03	20-400	Open-Top	Red	Yes	300
240716-04	20-400	Open-Top	Blue	Yes	300
240716-05	20-400	Open-Top	Yellow	Yes	300





Stopper, Thin Flange

- Use with screw caps for Screw Neck Diagnostic Vials
- Autoclavable



Cat. No.	Stopper Size	Qty / Case
224100-203	20mm 3-Leg Lyophilization Gray Chlorobutyl / 55	300
W224100-195	20mm Thin Flange Snap-On Gray Chlorobutyl / 50	300

Sample Vial Sizer Guide (Approximate Size)

-  Sample Vial in Lab File® (w/ cap attached)
-  Sample Vial in Lab File® w/ Writing Patch (w/ cap attached)
-  Sample Vial in Lab File® (w/o cap attached)
-  Sample Vial in Vial File® (w/ cap attached)
-  E-C Sample Vial

Standard Sample Vials

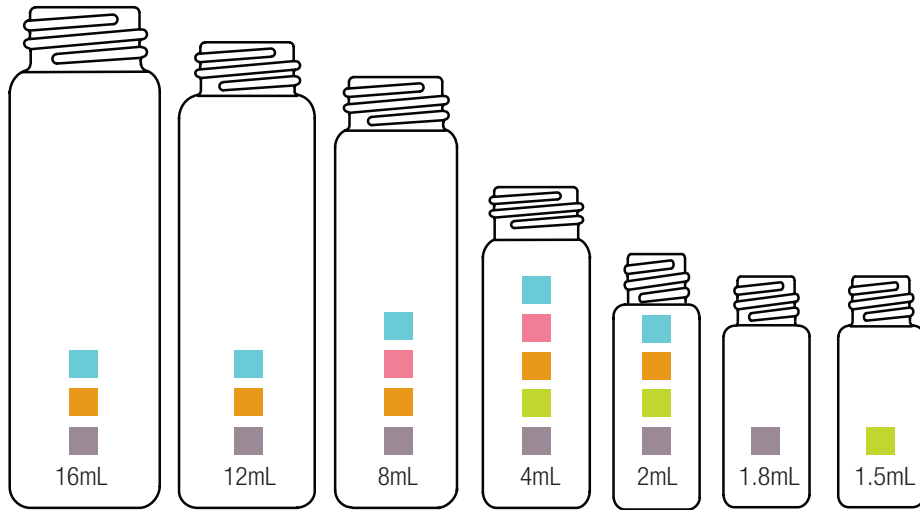

Shorty Vials®

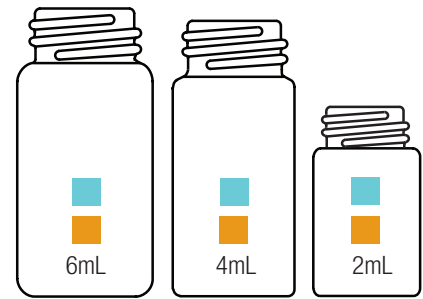

Standard Sample Vials



Sample Vials in Lab File® (With Caps Attached)



Shorty Vials®



Standard Clear and Amber Vials

- Sample vials with caps attached to vial help maintain cleanliness
- Lab File® with partitioned trays provides an easy way to inventory samples or to store empty vials
- Clear vials made from low extractable borosilicate glass to provide superior chemical resistance
- Clear vials conform to USP Type I and ASTM E 438 Type I, Class A requirements
- Amber vials made from borosilicate glass that conforms to USP Type I requirements for light transmission to protect light-sensitive products
- Shorty Vials® feature a low profile for greater stability and less dead volume
- 14B rubber lined black phenolic screw cap for aqueous samples
- PTFE / 14B rubber lined black phenolic screw cap for organic samples
- Replacement caps can be purchased separately
- Vials and caps are autoclavable

Cat. No.	Color	Size (mL)	Size (dr)	Cap Material	Cap Description	Liner Material	Cap Size	Dia. x H (mm)	Qty / Case	Fits M-T File®	Fits Vial Rack
Shorty Vials with Caps Attached											
W225291	Clear	2	.5	Black Phenolic	Solid Top	14B Rubber	13-425	15 x 31	200	228780	868804
W224606	Clear	2	.5	Black Phenolic	Solid Top	PTFE/14B Rubber	13-425	15 x 31	200	228780	868804
W225292	Clear	4	1	Black Phenolic	Solid Top	14B Rubber	15-425	17 x 41	200	—	868810
W224607	Clear	4	1	Black Phenolic	Solid Top	PTFE/14B Rubber	15-425	17 x 41	200	—	868810
W225293	Clear	6	1.5	Black Phenolic	Solid Top	14B Rubber	15-425	19 x 43	200	—	—
W224608	Clear	6	1.5	Black Phenolic	Solid Top	PTFE/14B Rubber	15-425	19 x 43	200	—	—
Standard Vials with Caps Attached											
224881	Clear	2	.5	Black Phenolic	Solid Top	14B Rubber	8-425	12 x 38	288	228778	985800
W224581	Clear	2	.5	Black Phenolic	Solid Top	PTFE/14B Rubber	8-425	12 x 38	288	228778	985800
224981	Amber	2	.5	Black Phenolic	Solid Top	14B Rubber	8-425	12 x 38	288	228778	985800
W224681	Amber	2	.5	Black Phenolic	Solid Top	PTFE/14B Rubber	8-425	12 x 38	288	228778	985800
225081	Clear	2	.5	White Urea	Solid Top	Metal Foil / Pulp	8-425	12 x 38	288	228778	985800
224882	Clear	4	1	Black Phenolic	Solid Top	14B Rubber	13-425	15 x 48	144	228780	868804
W224582	Clear	4	1	Black Phenolic	Solid Top	PTFE/14B Rubber	13-425	15 x 48	144	228780	868804
224982	Amber	4	1	Black Phenolic	Solid Top	14B Rubber	13-425	15 x 48	144	228780	868804
W224682	Amber	4	1	Black Phenolic	Solid Top	PTFE/14B Rubber	13-425	15 x 48	144	228780	868804
224884	Clear	8	2	Black Phenolic	Solid Top	14B Rubber	15-425	17 x 63	144	W228790	868810
W224584	Clear	8	2	Black Phenolic	Solid Top	PTFE/14B Rubber	15-425	17 x 63	144	W228790	868810
224984	Amber	8	2	Black Phenolic	Solid Top	14B Rubber	15-425	17 x 63	144	W228790	868810
W224684	Amber	8	2	Black Phenolic	Solid Top	PTFE/14B Rubber	15-425	17 x 63	144	W228790	868810
224885	Clear	12	3	Black Phenolic	Solid Top	14B Rubber	15-425	19 x 68	144	—	—
W224585	Clear	12	3	Black Phenolic	Solid Top	PTFE/14B Rubber	15-425	19 x 68	144	—	—
224886	Clear	16	4	Black Phenolic	Solid Top	14B Rubber	18-400	21 x 73	144	—	—
W224586	Clear	16	4	Black Phenolic	Solid Top	PTFE/14B Rubber	18-400	21 x 73	144	—	—
225288	Clear	20	5	Black Phenolic	Solid Top	14B Rubber	24-400	28 x 60	72	W228792	868806
W224589	Clear	20	5	Black Phenolic	Solid Top	PTFE/14B Rubber	24-400	28 x 60	72	W228792	868806
W224820	Amber	20	5	Black Phenolic	Solid Top	14B Rubber	24-400	28 x 60	72	W228792	868806
W224604	Amber	20	5	Black Phenolic	Solid Top	PTFE/14B Rubber	24-400	28 x 60	72	W228792	868806
224888	Clear	24	6	Black Phenolic	Solid Top	14B Rubber	20-400	23 x 88	144	—	868805
W224588	Clear	24	6	Black Phenolic	Solid Top	PTFE/14B Rubber	20-400	23 x 88	144	—	868805
225289	Clear	25	6.76	Black Phenolic	Solid Top	14B Rubber	24-400	28 x 73	72	—	868806
W224590	Clear	25	6.76	Black Phenolic	Solid Top	PTFE/14B Rubber	24-400	28 x 73	72	—	868806
225290	Clear	40	10.8	Black Phenolic	Solid Top	14B Rubber	24-400	28 x 98	72	—	868806
W224591	Clear	40	10.8	Black Phenolic	Solid Top	PTFE/14B Rubber	24-400	28 x 98	72	—	868806
W224840	Amber	40	10.8	Black Phenolic	Solid Top	14B Rubber	24-400	28 x 98	72	—	868806
W224605	Amber	40	10.8	Black Phenolic	Solid Top	PTFE/14B Rubber	24-400	28 x 98	72	—	868806
Standard Vials with Writing Patch and Caps Attached											
225012	Clear	4	1	Black Phenolic	Solid Top	14B Rubber	13-425	15 x 48	144	228780	868804
225014	Clear	8	2	Black Phenolic	Solid Top	14B Rubber	15-425	17 x 63	144	W228790	868810

Sample Vials in Lab File® (Without Caps)

- Sample vials packaged in partitioned trays without caps
- Partitioned trays provide an easy way to inventory samples or to store empty vials
- Clear vials made from low extractable borosilicate glass that provides superior chemical resistance
- Clear vials conform to USP Type I and ASTM E 438 Type I, Class A requirements
- Amber vials made from borosilicate glass that conforms to USP Type I requirements for light transmission to protect light-sensitive products
- Shorty Vials® feature a low profile for greater stability and less dead volume
- Screw caps can be purchased separately
- Vials are autoclavable

Cat. No.	Color	Size (mL)	Size (dr)	Cap Size	Dia. x H (mm)	Qty / Case	Fits M-T File®	Fits Vial Rack
Shorty Vials without Caps								
224821	Clear	2	.5	13-425	15 x 28	200	228780	868804
224822	Clear	4	1	15-425	17 x 38	200	—	868810
224823	Clear	6	1.5	15-425	19 x 40	200	—	—
Standard Vials without Caps								
224801	Clear	2	.5	8-425	12 x 35	200	228778	985800
224811	Amber	2	.5	8-425	12 x 35	200	228778	985800
224802	Clear	4	1	13-425	15 x 45	200	228780	868804
224812	Amber	4	1	13-425	15 x 45	200	228780	868804
224804	Clear	8	2	15-425	17 x 60	200	W228790	868810
224814	Amber	8	2	15-425	17 x 60	200	W228790	868810
224805	Clear	12	3	15-425	19 x 65	200	—	—
224806	Clear	16	4	18-400	21 x 70	200	—	—
224831	Clear	20	5	24-400	28 x 57	200	W228792	868806
W224815	Amber	20	5	24-400	28 x 57	200	W228792	868806
224808	Clear	24	6	20-400	23 x 85	200	—	868805
224832	Clear	25	6.76	24-400	28 x 70	200	—	868806
W224834	Clear	30	8	22-400	25 x 95	200	—	—
224833	Clear	40	10.8	24-400	28 x 95	200	—	868806
224836	Amber	40	10.8	24-400	28 x 95	200	—	868806

Sample Vials in Vial File®

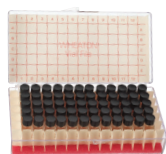

224891



224892



W224896

- Sample Vials in Vial File provides a compact, easily accessible means of sample storage
- Polystyrene case with partitions, foam inserts and alphanumeric indexing card organize and protect vials
- Clear vials are manufactured from low extractable borosilicate glass that conforms to USP Type I and ASTM E 438 Type I, Class A requirements
- Amber vials made from borosilicate glass that conforms to USP Type I requirements for light transmission to protect light-sensitive products
- Choice of solid or open top black phenolic screw cap
- Open top screw cap provides for sample retrieval with a syringe
- Caps attached to vials
- Vials and caps are autoclavable

Cat. No.	Color	Size (mL)	Size (dr)	Graduations	Cap Style	Cap Material	Liner Material	Cap Size	Dia. x H (mm)	Vials/File	Qty / Case
224950	Clear	1.5	.375	No	Open Top	Black Phenolic	PTFE/Silicone	8-425	12 x 35	60	1
W224954	Amber	1.5	.375	No	Open Top	Black Phenolic	PTFE/Silicone	8-425	12 x 35	60	1
224891	Clear	2	.5	No	Solid Top	Black Phenolic	14B Rubber	8-425	12 x 38	60	1
W224693	Clear	2	.5	No	Solid Top	Black Phenolic	PTFE/14B Rubber	8-425	12 x 38	60	1
W224896	Amber	2	.5	No	Solid Top	Black Phenolic	14B Rubber	8-425	12 x 38	60	1
W224695	Amber	2	.5	No	Solid Top	Black Phenolic	PTFE/14B Rubber	8-425	12 x 38	60	1
224892	Clear	4	1	No	Solid Top	Black Phenolic	14B Rubber	13-425	15 x 48	40	1
W224694	Clear	4	1	No	Solid Top	Black Phenolic	PTFE/14B Rubber	13-425	15 x 48	40	1
224952	Clear	4	1	No	Open Top	Black Phenolic	PTFE/Silicone	13-425	15 x 48	40	1
W224897	Amber	4	1	No	Solid Top	Black Phenolic	14B Rubber	13-425	15 x 48	40	1
W224696	Amber	4	1	No	Solid Top	Black Phenolic	PTFE/14B Rubber	13-425	15 x 48	40	1
W224955	Amber	4	1	No	Open Top	Black Phenolic	PTFE/Silicone	13-425	15 x 48	40	1

E-C Sample Vials



- E-Conomically priced by packaging vials and screw caps separately
- Clear vials made from low extractable borosilicate glass that provides superior chemical resistance
- Clear vials conform to USP Type I and ASTM E 438 Type I, Class A requirements
- Amber vials made from borosilicate glass that conforms to USP Type I requirements for light transmission to protect light-sensitive products
- Vials packed in two shrink-wrapped packs of 100 vials which reduces contamination from corrugate
- 14B rubber lined black phenolic screw cap for aqueous samples
- PTFE-faced 14B rubber lined black phenolic screw cap for organic samples
- Caps and replacement caps can be purchased separately
- Vials and caps are autoclavable

Cat. No.	Color	Size (mL)	Size (dr)	Cap Material	Liner Material	Cap Size	Dia. x H (mm)	Qty / Case	Fits M-T File*	Fits Vial Rack
224700	Clear	1.8	.375	—	—	8-425	12 x 32	200	228778	985800
224710	Amber	1.8	.375	—	—	8-425	12 x 32	200	228778	985800
224720	Clear	1.8	.375	Black Phenolic	14B Rubber	8-425	12 x 35**	200	228778	985800
224740	Clear	1.8	.375	Black Phenolic	PTFE/14B Rubber	8-425	12 x 35**	200	228778	985800
224730	Amber	1.8	.375	Black Phenolic	14B Rubber	8-425	12 x 35**	200	228778	985800
224750	Amber	1.8	.375	Black Phenolic	PTFE/14B Rubber	8-425	12 x 35**	200	228778	985800
224701	Clear	2	.5	—	—	8-425	12 x 35	200	228778	985800
224711	Amber	2	.5	—	—	8-425	12 x 35	200	228778	985800
224721	Clear	2	.5	Black Phenolic	14B Rubber	8-425	12 x 38**	200	228778	985800
224741	Clear	2	.5	Black Phenolic	PTFE/14B Rubber	8-425	12 x 38**	200	228778	985800
224731	Amber	2	.5	Black Phenolic	14B Rubber	8-425	12 x 38**	200	228778	985800
224751	Amber	2	.5	Black Phenolic	PTFE/14B Rubber	8-425	12 x 38**	200	228778	985800
224702	Clear	4	1	—	—	13-425	15 x 45	200	228780	868804
224712	Amber	4	1	—	—	13-425	15 x 45	200	228780	868804
224722	Clear	4	1	Black Phenolic	14B Rubber	13-425	15 x 48**	200	228780	868804
224742	Clear	4	1	Black Phenolic	PTFE/14B Rubber	13-425	15 x 48**	200	228780	868804
224732	Amber	4	1	Black Phenolic	14B Rubber	13-425	15 x 48**	200	228780	868804
224752	Amber	4	1	Black Phenolic	PTFE/14B Rubber	13-425	15 x 48**	200	228780	868804
224704	Clear	8	2	—	—	15-425	17 x 60	200	W228790	868810
224714	Amber	8	2	—	—	15-425	17 x 60	200	W228790	868810
224724	Clear	8	2	Black Phenolic	14B Rubber	15-425	17 x 63**	200	W228790	868810
224744	Clear	8	2	Black Phenolic	PTFE/14B Rubber	15-425	17 x 63**	200	W228790	868810
224734	Amber	8	2	Black Phenolic	14B Rubber	15-425	17 x 63**	200	W228790	868810
224754	Amber	8	2	Black Phenolic	PTFE/14B Rubber	15-425	17 x 63**	200	W228790	868810
224705	Clear	12	3	—	—	15-425	19 x 65	200	—	—
224725	Clear	12	3	Black Phenolic	14B Rubber	15-425	19 x 68**	200	—	—
224745	Clear	12	3	Black Phenolic	PTFE/14B Rubber	15-425	19 x 68**	200	—	—
224706	Clear	16	4	—	—	18-400	21 x 70	200	—	—
224726	Clear	16	4	Black Phenolic	14B Rubber	18-400	21 x 73**	200	—	—
224746	Clear	16	4	Black Phenolic	PTFE/14B Rubber	18-400	21 x 73**	200	—	—
W224809	Clear	20	5	—	—	24-400	28 x 57	200	W228792	868806
224708	Clear	24	6	—	—	20-400	23 x 85	200	—	868805
224728	Clear	24	6	Black Phenolic	14B Rubber	20-400	23 x 88**	200	—	868805
224748	Clear	24	6	Black Phenolic	PTFE/14B Rubber	20-400	23 x 88**	200	—	868805
W224810	Clear	40	10.8	—	—	24-400	28 x 95	200	—	868806
W226060*	Clear	60	15	—	—	24-400	30 x 125	143	—	868808

* Includes one shrink-wrapped pack of 143 vials ** Measurement with cap attached

Screw Caps for Sample Vials



Black Phenolic



White Polypropylene Solid Top



White Polypropylene Open Top

- Choice of black phenolic, white polypropylene or urea screw caps
- PTFE faced (14B) styrene-butadiene rubber liner provides a totally inert inner seal and surface facing the sample or product
- Bonded PTFE faced silicone liner ideal for storage of volatile solvents, sensitive compounds and corrosive chemicals
- Open top screw caps have a bonded PTFE faced silicone liner that provides access with a syringe
- Pre-slit PTFE / Silicone liner easily pierced by liquid handling needles
- Can withstand autoclaving / sterilization

Cat. No.	Cap Size	Cap Style	Cap Material	Color	Cap Liner	Autoclavable	Qty / Case
240206	8-425	Solid Top	Phenolic	Black	14B Rubber	Yes	1000
W240406	8-425	Solid Top	Phenolic	Black	PTFE/14B Rubber	Yes	200
240208	13-425	Solid Top	Phenolic	Black	14B Rubber	Yes	200
240408	13-425	Solid Top	Phenolic	Black	PTFE/14B Rubber	Yes	200
239249	13-425	Solid Top	Phenolic	Black	PE Cone	No	144
239201	13-425	Solid Top	Polypropylene	White	Poly-Vinyl	No	144
239273	13-425	Solid Top	Polypropylene	White	Foamed PE	No	144
239225	13-425	Solid Top	Polypropylene	White	PTFE/Foamed PE	No	144
W240830	13-425	Solid Top	Polypropylene	White	Bonded PTFE/Silicone	Yes	250
W242710	13-425	Open Top	Polypropylene	Black	Bonded PTFE/Silicone	Yes	250
W240848	13-425	Open Top	Polypropylene	Black	Pre-Slit Bonded PTFE/Silicone	Yes	250
240209	15-425	Solid Top	Phenolic	Black	14B Rubber	Yes	200
240409	15-425	Solid Top	Phenolic	Black	PTFE/14B Rubber	Yes	200
239250	15-425	Solid Top	Phenolic	Black	PE Cone	No	144
239202	15-425	Solid Top	Polypropylene	White	Poly-Vinyl	No	144
239274	15-425	Solid Top	Polypropylene	White	Foamed PE	No	144
239226	15-425	Solid Top	Polypropylene	White	PTFE/Foamed PE	No	144
W240832	15-425	Solid Top	Polypropylene	White	Bonded PTFE/Silicone	Yes	250
W240842	15-425	Open Top	Polypropylene	White	Bonded PTFE/Silicone	Yes	250
W240850	15-425	Open Top	Polypropylene	Black	Pre-Slit Bonded PTFE/Silicone	Yes	250
241009	15-425	Closed Top	Urea	White	Metal Foil	No	1000
240215	18-400	Solid Top	Phenolic	Black	14B Rubber	Yes	500
240415	18-400	Solid Top	Phenolic	Black	PTFE/14B Rubber	Yes	200
239251	18-400	Solid Top	Phenolic	Black	PE Cone	No	144
239203	18-400	Solid Top	Polypropylene	White	Poly-Vinyl	No	144
239275	18-400	Solid Top	Polypropylene	White	Foamed PE	No	144
239227	18-400	Solid Top	Polypropylene	White	PTFE/Foamed PE	No	144
W239298	20-400	Solid Top	Phenolic	Black	14B Rubber	Yes	144
240416	20-400	Solid Top	Phenolic	Black	PTFE/14B Rubber	Yes	100
239253	20-400	Solid Top	Phenolic	Black	PE Cone	No	144
239229	20-400	Solid Top	Polypropylene	White	PTFE/Foamed PE	No	144
W239300	24-400	Solid Top	Phenolic	Black	14B Rubber	Yes	144
240418	24-400	Solid Top	Phenolic	Black	PTFE/14B Rubber	Yes	100
W242711	24-400	Solid Top	Phenolic	Black	PTFE/14B Rubber	Yes	200
239257	24-400	Solid Top	Phenolic	Black	PE Cone	No	144
239209	24-400	Solid Top	Polypropylene	White	Poly-Vinyl	No	144
239281	24-400	Solid Top	Polypropylene	White	Foamed PE	No	144
239233	24-400	Solid Top	Polypropylene	White	PTFE/Foamed PE	No	144
W240836	24-400	Solid Top	Polypropylene	White	Bonded PTFE/Silicone	Yes	100
W240846	24-400	Open Top	Polypropylene	White	Bonded PTFE/Silicone	Yes	100
241018	24-400	Solid Top	Urea	White	Metal Foil	No	1000

Serum Tubing Vials



- 2 - 20mL size
- Clear vials manufactured from low extractable borosilicate glass that conforms to USP Type I and ASTM E 438 Type I, Class A requirements
- Amber glass conforms to USP Type I requirements to protect light-sensitive samples
- Tubular design provides excellent clarity and dimensional consistency from vial to vial
- Specially designed bottom radius adds strength for lyophilization applications
- Lighter weight compared to molded bottles
- Shrink-wrapped modules reduce particulate contamination
- Autoclavable

Cat. No.	Size (mL)	Mouth ID x OD (mm)	Dia. x H	Qty / Case	Fits Rack
Clear Serum Vials					
223683	2	7 x 13	15 x 32	144	868804
223684	3	7 x 13	17 x 38	144	868810
223685	5	13 x 20	22 x 40	144	868805
223686	10	13 x 20	24 x 50	144	—
223687	20	13 x 20	30.5 x 58	120	—
Amber Serum Vials					
223693	2	7 x 13	15 x 32	144	868804
223695	5	13 x 20	22 x 40	144	868805
223696	10	13 x 20	24 x 50	144	—

Note: When selecting a rubber stopper or aluminum seal, match the mouth OD dimension of the vial.

Serum Bottle

- Ideal for long and short term sample storage, lyophilization and vaccine / injectable drug containers
- Fits most lyophilization applications
- Borosilicate glass conforms to USP Type I requirements
- Clear bottles manufactured from WHEATON 400 borosilicate molded glass that conforms to USP Type I requirements
- Amber bottles manufactured from WHEATON 500 borosilicate glass that conforms to USP Type I requirements
- Shrink-wrapped partitioned modules reduce breakage

Cat. No.	Color	Size (mL)	Mouth ID x OD (mm)	Dia. x H (mm)	Fits Rack	Qty / Case
W223712	Clear	2	7 x 13	15.6 x 36	868810	288
223738	Clear	5	13 x 20	23 x 47	868805	288
223760	Amber	5	13 x 20	23 x 47	868805	288
223739	Clear	10	13 x 20	25 x 54	868806	288
223761	Amber	10	13 x 20	25 x 54	868806	288
223742	Clear	20	13 x 20	32 x 58	—	288
223762	Amber	20	13 x 20	32 x 58	—	288
223743	Clear	30	13 x 20	37 x 63	—	288
223763	Amber	30	13 x 20	37 x 63	—	288
223745	Clear	50	13 x 20	43 x 73	—	288
223764	Amber	50	13 x 20	43 x 73	—	288
223746	Clear	60	13 x 20	41 x 91	—	144
223747	Clear	100	13 x 20	52 x 95	—	144
223766	Amber	100	13 x 20	52 x 95	—	144
223748	Clear	125	13 x 20	54 x 107	—	144

*Note: Select aluminum seal and stopper size by using the mouth OD dimension of the bottle or vial

Serum Bottle, PVC Dropper Tip

- Create a dropper container using a crimp / serum bottle with 20mm mouth OD
- Dropper tip is made from PVC with HDPE closure
- Dispenses 40µL drop using water



Part. No.	Description	Dia. x H (mm)	Qty / Case
224080	PVC Dropper Tip	23 x 44	100

Vacule® Vial

- Heavy wall construction designed for lyophilization and freeze-drying applications
- Screw threads eliminate use of crimp seal
- Manufactured from WHEATON 33 low extractable clear borosilicate glass that conforms to USP Type I and ASTM E 438 Type I, Class A requirements
- Vacule vials have controlled ID, for accurate stopper fit
- Choice of solid or open top screw cap
- 651905 and 651907 are supplied with unlined black phenolic cap



Cat. No.	Size (mL)	Dia. x H (mm)	Cap Finish Size	Fits Rack	Qty / Case
Vacule® Vial					
651954*	4	17 x 45	15-425	868810	200
651905	5	22 x 40	22-350	868805	200
651907	10	22 x 55	22-350	868805	200

Cat. No.	Description	Qty/Pack	Qty / Case
15-425 Screw Thread Caps and Stoppers for Cat. No. 651954			
224100-080	Red Rubber Stopper	100	1000
W224100-093	Lyophilization Stopper, 2-Leg	100	1000
240209	Cap, Solid Top, Rubber Liner	200	200
W240509	Cap, Open Top, without Liner	200	200
22-350 Screw Thread Caps and Stoppers for Cat. No. 651905 and 651907			
224100-172	Red Rubber Stoppers	100	1000
W224100-193	Lyophilization Stopper, 2-Leg	100	1000
W224100-202	Lyophilization Stopper, 3-Leg	100	1000
239853	Cap, Solid Top, without Liner	500	500

*Purchase closures separately



Aluminum Seals (Unlined)



- Wide range of styles and sizes
- Color selection includes natural, red, blue and green
- Open top seals expose stopper for sample retrieval with a syringe
- Tear-off seal removes completely allowing content to pour from bottle
- Solid top seals are excellent for long-term storage of samples
- Flip cap seals provide tamper evidence

Cat. No.	For Mouth OD (mm)	Style	Color	Qty / Case
224176-01	11	Open Top	Natural	1000
224176-05	11	Open Top	Blue	1000
224176-06	11	Open Top	Red	1000
224176-07	11	Open Top	Green	1000
224189	11	Solid-Top	Natural	1000
224177-01	13	Open Top	Natural	1000
224177-05	13	Open Top	Blue	1000
224177-06	13	Open Top	Red	1000
224182-01	13	Center Disc Tear-Out	Natural	1000
224182-05	13	Center Disc Tear-Out	Blue	1000
224182-06	13	Center Disc Tear-Out	Red	1000
224182-07	13	Center Disc Tear-Out	Green	1000
224192-01	13	Complete Tear-Off	Natural	1000
224192-05	13	Complete Tear-Off	Blue	1000
224192-06	13	Complete Tear-Off	Red	1000
224192-07	13	Complete Tear-Off	Green	1000
224202	13	Flip Cap	Red	1000
W224207	13	Flip Cap Tear-Off	Red	1000
224178-01	20	Open Top	Natural	1000
224178-05	20	Open Top	Blue	1000
224178-06	20	Open Top	Red	1000
224178-07	20	Open Top	Green	1000
224183-01	20	Center Disc Tear-Out	Natural	1000
224183-05	20	Center Disc Tear-Out	Blue	1000
224183-06	20	Center Disc Tear-Out	Red	1000
224183-07	20	Center Disc Tear-Out	Green	1000
224191	20	Solid-Top	Natural	1000
224193-01	20	Complete Tear-Off	Natural	1000
224193-05	20	Complete Tear-Off	Blue	1000
224193-06	20	Complete Tear-Off	Red	1000
224193-07	20	Complete Tear-Off	Green	1000
224203	20	Flip Cap	Red	1000
W224205	20	Flip Cap	White	1000
224208	20	Flip Cap Tear-Off	Red	1000
224187-01	30	Center Disc Tear-Out	Natural	1000
224197-01	30	Complete Tear-Off	Natural	1000

Ultra Pure Stoppers

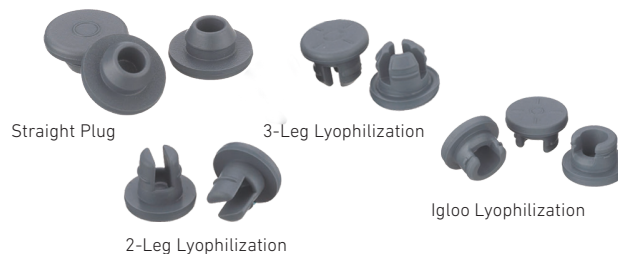

- Manufactured from an ultra pure bromobutyl formulation with extremely high chemical purity and low gas permeability
- Free of latex, nitrosamines and 2-MCBT (2-mercaptobenzothiazole)
- Compatible with applications such as Water for Injection (WFI) where rubber extractables can cause problems
- Complies with US, European and Japanese Pharmacopeias

Straight Plug Stoppers

- Low level of extractables
- Autoclavable

Cat. No.	For Mouth ID x OD (mm)	Material Stopper	Durometer	Qty / Case
W224100-400	7 x 13	Gray Bromobutyl	47	1000
W224100-405	13 x 20	Gray Bromobutyl	47	1000

Lyophilization Stoppers

- Available in 2-Leg, 3-Leg and Igloo styles
- Demonstrates a very low level of moisture adsorption
- Very low adsorption of the preservatives present in aqueous parenteral solutions
- Autoclavable

Cat. No.	For Mouth ID x OD (mm)	Material Stopper	Durometer	Qty / Case
2-Leg Lyophilization				
W224100-406	13 x 20	Gray Bromobutyl	46	1000
3-Leg Lyophilization				
W224100-407	13 x 20	Gray Bromobutyl	46	1000
Igloo Lyophilization				
W224100-402	7 x 13	Gray Bromobutyl	46	1000
W224100-408	13 x 20	Gray Bromobutyl	46	1000

Complete Coat Stoppers

- Stoppers are completely coated with a fluorinated polymer
- Manufactured in a silicone-free environment
- PTFE like coatings prevents reactions due to sample contact with rubber
- Autoclavable

Cat. No.	For Mouth ID x OD (mm)	Material Stopper	Durometer	Qty / Case
Straight Plug Stopper				
W224100-420	7 x 13	Gray Bromobutyl	39	1000
W224100-421	13 x 20	Gray Bromobutyl	39	1000

Rubber Stoppers



- Variety of styles, sizes and rubber formulations
- Manufactured from the highest quality raw materials
- Components manufactured to yield exceptional dimensional stability
- Straight plug stoppers provide maximum sealing for vials with straight-wall glass finish
- Snap-on style provides maximum sealing for vials with a blow-back glass finish
- Sleeve style stoppers feature a fold-over skirt for sealing in serum finish vials without a crimp closure
- Autoclavable

Cat. No.	For Mouth ID x OD (mm)	Style	Stopper Material	*Durometer	Shelf Pack	Qty / Case
224100-020	5 x 11	Sleeve	Natural Red Rubber	39	100	1000
224100-070	7 x 13	Straight Plug	Natural Red Rubber	40	100	1000
224100-072	7 x 13	Straight Plug	Gray Chlorobutyl-Isoprene Blend/FEP Faced	40	100	1000
W224100-093	7 x 13	2-Leg Lyophilization	Gray Chlorobutyl	50	100	1000
224100-060	7 x 13	Sleeve	Natural Red Rubber	39	100	1000
224100-080	7 x 13	Snap-On	Natural Red Rubber	40	100	1000
W224100-081	7 x 13	Snap-On	Gray Chlorobutyl	55	100	1000
224100-170	10 x 20	Straight Plug	Natural Red Rubber	40	100	1000
224100-160	10 x 20	Sleeve	Natural Red Rubber	39	100	1000
224100-171	13 x 20	Straight Plug	Natural Pink Rubber	48	100	1000
224100-172	13 x 20	Straight Plug	Natural Red Rubber	45	100	1000
W224100-173	13 x 20	Straight Plug	Gray Chlorobutyl	46	100	1000
224100-174	13 x 20	Straight Plug	Gray Chlorobutyl-Isoprene Blend	40	100	1000
224100-175	13 x 20	Straight Plug	Gray Chlorobutyl-Isoprene Blend/FEP Faced	40	—	1000
224100-177	13 x 20	Straight Plug	Black FKM	55	—	100
224100-178	13 x 20	Straight Plug	Silicone	55	100	1000
W224100-195	13 x 20	Snap-On – Thin Flange	Gray Chlorobutyl	49	100	300
224100-192	13 x 20	2-Leg Lyophilization	Gray Chlorobutyl-Isoprene Blend	50	100	1000
W224100-193	13 x 20	2-Leg Lyophilization	Gray Chlorobutyl	46	100	1000
W224100-202	13 x 20	3-Leg Lyophilization	Gray Chlorobutyl	46	100	1000
224100-203	13 x 20	3-Leg Lyophilization – Thin Flange	Gray Chlorobutyl	55	—	300
224100-161	13 x 20	Sleeve	Natural Red Rubber	39	100	1000
224100-180	13 x 20	Snap-On	Natural Red Rubber	45s	100	1000
W224100-181	13 x 20	Snap-On	Gray Chlorobutyl	46	100	1000
224100-330	15 x 30	Straight Plug	Natural Red Rubber	40s	100	1000
224100-331	15 x 30	Straight Plug	Gray Bromobutyl	50	100	1000
224100-320	15 x 30	Sleeve	Natural Red Rubber	39	100	1000
W224100-342	15 x 30	Snap-On	Gray Bromobutyl	52	100	1000
W224100-282	20 x 28	2-Leg Lyophilization	Gray Chlorobutyl	46	100	1000

*Durometer is a measure of the resistance of a material to indentation. The higher the number, the greater the resistance. The Shore A scale is used for soft elastomers. The term durometer is often used to refer to the measurement, as well as the instrument itself.

High Recovery Vials

NextGen™ V Vials®



WHEATON NextGen™ V Vials® are ideal for small scale reactions, centrifugation, storage, packaging and shipping of vital samples. The conical interior provides downward drainage for maximum sample retrieval. Low particulate packaging protects against contamination during transportation and storage. Clear vials conform to USP Type I and ASTM E 438 Type I, Class A requirements. Amber vials are made from amber borosilicate glass that conforms to USP Type I requirements for light transmission to protect light-sensitive products. Vials are available graduated or non-graduated, as well as with the option for screw thread or crimp / serum finish. Closures for either finish can be purchased separately.

The steep conical V interior bottom provides exceptional downward drainage while allowing maximum retrieval of contents by syringe. V Vials are perfect for specialty pharma, biotech, pharmaceutical and diagnostics packaging applications.

NextGen V Vials are manufactured from heavy wall, low extractable, borosilicate glass providing excellent chemical resistance and durability during packaging and transportation.

NextGen™ V Vials®



- Conical interior provides downward drainage for maximum sample retrieval
- Ideal for small-scale reactions, centrifugation, storage, packaging and shipping
- Low particulate packaging protects against contamination during transportation and storage
- Clear vials conform to USP Type I and ASTM E 438 Type I, Class A requirements
- Amber vials made from amber borosilicate glass that conforms to USP Type I requirements for light transmission to protect light-sensitive products
- Graduated or non-graduated
- Choose screw thread or crimp / serum finish
- Closures for crimp / serum finish vials can be purchased separately

Spin Vanes

- Magnetic stir bar for use with NextGen™ V Vials®
- Made from PTFE
- Place stir bar in vial and use with magnetic stirrer



Cat. No.	Description	Qty / Case
903061	Fits 0.3 and 1.0mL V Vials	6
903063	Fits 2, 3, 5 and 10mL V Vials	6

Cat. No.	Color	Size (mL)	Graduated	Cap Style	Cap Material	Cap Color	Liner Material	Cap Size	Dia. x H (mm)	Qty / Case
W986281NG	Clear	0.1	No	Open Top, Screw Cap	Phenolic	Black	PTFE / Silicone	8-425	12 x 35	12
W986211NG*	Clear	0.1	No	Crimp Top, purchase closure separately	—	—	—	11mm	12 x 32	12
W986273NG	Clear	0.3	Yes	Solid Top, Screw Cap	Phenolic	Black	PTFE / 14B Rubber	13-425	13 x 35	12
W986253NG	Clear	0.3	No	Solid Top, Screw Cap	Phenolic	Black	PTFE / 14B Rubber	13-425	13 x 35	12
W986282NG	Clear	0.3	No	Open Top, Screw Cap	Phenolic	Black	PTFE / Silicone	8-425	12 x 35	12
W986283NG	Clear	0.3	No	Open Top, Screw Cap	Phenolic	Black	PTFE / Silicone	13-425	13 x 35	12
W986293NG	Clear	0.3	Yes	Open Top, Screw Cap	Phenolic	Black	PTFE / Silicone	13-425	13 x 35	12
W986212NG*	Clear	0.3	No	Crimp Top, purchase closure separately	—	—	—	11mm	12 x 32	12
W986213NG*	Clear	0.3	No	Crimp Top, purchase closure separately	—	—	—	13mm	13 x 32	12
W986274NG	Clear	1.0	Yes	Solid Top, Screw Cap	Phenolic	Black	PTFE / 14B Rubber	13-425	13 x 44	12
W986254NG	Clear	1.0	No	Solid Top, Screw Cap	Phenolic	Black	PTFE / 14B Rubber	13-425	13 x 44	12
W986284NG	Clear	1.0	No	Open Top, Screw Cap	Phenolic	Black	PTFE / Silicone	13-425	13 x 44	12
W986294NG	Clear	1.0	Yes	Open Top, Screw Cap	Phenolic	Black	PTFE / Silicone	13-425	13 x 44	12
W986334NG	Amber	1.0	No	Solid Top, Screw Cap	Phenolic	Black	PTFE / 14B Rubber	13-425	13 x 44	12
W986354NG	Amber	1.0	No	Open Top, Screw Cap	Phenolic	Black	PTFE / Silicone	13-425	13 x 44	12
W986314NG*	Amber	1.0	No	Screw Cap, purchase closure separately	—	—	—	13-425	13 x 41	12
W986214NG*	Clear	1.0	No	Crimp Top, purchase closure separately	—	—	—	13mm	13 x 41	12
W986276NG	Clear	2.0	Yes	Solid Top, Screw Cap	Phenolic	Black	PTFE / 14B Rubber	15-415	17 x 61	12
W986272NG	Clear	2.0	Yes	Solid Top, Screw Cap	Phenolic	Black	PTFE / 14B Rubber	20-400	20 x 44	12
W986256NG	Clear	2.0	No	Solid Top, Screw Cap	Phenolic	Black	PTFE / 14B Rubber	15-415	17 x 61	12
W986261NG	Clear	2.0	No	Solid Top, Screw Cap	Phenolic	Black	PTFE / 14B Rubber	20-400	20 x 44	12
W986288NG	Clear	2.0	No	Open Top, Screw Cap	Phenolic	Black	PTFE / Silicone	20-400	20 x 44	12
W986298NG	Clear	2.0	Yes	Open Top, Screw Cap	Phenolic	Black	PTFE / Silicone	20-400	20 x 44	12
W986336NG	Amber	2.0	No	Solid Top, Screw Cap	Phenolic	Black	PTFE / 14B Rubber	20-400	20 x 44	12
W986356NG	Amber	2.0	No	Open Top, Screw Cap	Phenolic	Black	PTFE / Silicone	20-400	20 x 44	12
W986316NG*	Amber	2.0	No	Screw Cap, purchase closure separately	—	—	—	20-400	20 x 41	12
W986216NG*	Clear	2.0	No	Crimp Top, purchase closure separately	—	—	—	20mm	20 x 40	12
W986277NG	Clear	3.0	Yes	Solid Top, Screw Cap	Phenolic	Black	PTFE / 14B Rubber	20-400	20 x 50	12
W986257NG	Clear	3.0	No	Solid Top, Screw Cap	Phenolic	Black	PTFE / 14B Rubber	20-400	20 x 50	12
W986287NG	Clear	3.0	No	Open Top, Screw Cap	Phenolic	Black	PTFE / Silicone	20-400	20 x 50	12
W986297NG	Clear	3.0	Yes	Open Top, Screw Cap	Phenolic	Black	PTFE / Silicone	20-400	20 x 50	12
W986217NG*	Clear	3.0	No	Crimp Top, purchase closure separately	—	—	—	20mm	20 x 46	12
W986279NG	Clear	5.0	Yes	Solid Top, Screw Cap	Phenolic	Black	PTFE / 14B Rubber	20-400	20 x 65	12
W986259NG	Clear	5.0	No	Solid Top, Screw Cap	Phenolic	Black	PTFE / 14B Rubber	20-400	20 x 65	12
W986289NG	Clear	5.0	No	Open Top, Screw Cap	Phenolic	Black	PTFE / Silicone	20-400	20 x 65	12
W986299NG	Clear	5.0	Yes	Open Top, Screw Cap	Phenolic	Black	PTFE / Silicone	20-400	20 x 65	12
W986339NG	Amber	5.0	No	Solid Top, Screw Cap	Phenolic	Black	PTFE / 14B Rubber	20-400	20 x 65	12
W986359NG	Amber	5.0	No	Open Top, Screw Cap	Phenolic	Black	PTFE / Silicone	20-400	20 x 65	12
W986319NG*	Amber	5.0	No	Screw Cap, purchase closure separately	—	—	—	20-400	20 x 62	12
W986219NG*	Clear	5.0	No	Crimp Top, purchase closure separately	—	—	—	20mm	20 x 61	12
W986260NG	Clear	10.0	No	Solid Top, Screw Cap	Phenolic	Black	PTFE / 14B Rubber	24-400	25.4 x 72	6
W986290NG	Clear	10.0	No	Open Top, Screw Cap	Phenolic	Black	PTFE / Silicone	24-400	25.4 x 72	6

* Purchase closures separately.

E-Z Ex-Traction® Vials



E-Z Ex-Traction Vials feature a revolutionary design that provides greater ease of handling, increased product recovery and improved storage capacity. A patented outer bottom configuration differentiates it from other vials enabling easy use with racks and automated equipment. The bottom well is manufactured to tight tolerances with a constant depth and shape, critical for automated systems that can be damaged by irregularities in vial dimensions. The interior walls transition smoothly into the conical well at the bottom preventing loss of product that would be trapped by irregularities. In addition, the high recovery conical bottom ensures the increased retrieval of valuable product.

E-Z Ex-Traction® Vials

- Conical well ensures maximum sample recovery
- Quality engineered for automated sample handling systems
- Excellent for chemical compound or biological sample storage
- Made from low extractable borosilicate glass that conforms to USP Type I and ASTM E 438 Type I, Class A requirements
- Vials can be easily bar coded using WHEATON customized services
- Screw caps can be purchased separately



Cat. No.	Color	Size (mL)	Size (dr)	Dia. x H (mm)	Cap Size	Qty / Case
W224601	Clear	2	.5	15 x 32	13-425	250
W224603	Clear	2	.5	15 x 32	13-425	1000
W224613	Clear	4	1	15 x 45	13-425	250
W224617	Clear	4	1	15 x 45	13-425	1000
W224618	Clear	8	2	16.75 x 60	15-425	250
W224619	Clear	8	2	16.75 x 60	15-425	1000
W224630	Clear	10	2.5	19 x 70	22-400	100
W224632	Clear	10	2.5	19 x 70	22-400	500
W224634	Clear	20	5	26.5 x 67	24-400	100
W224636	Clear	20	5	26.5 x 67	24-400	500

E-Z Ex-Traction® Vial Screw Caps

- Choice of black phenolic or white polypropylene screw caps
- PTFE faced (14B) styrene-butadiene rubber liner provides an inert inner seal and surface facing the sample or product
- Bonded PTFE faced silicone liner ideal for storage of volatile solvents, sensitive compounds and corrosive chemicals
- Open top screw caps have a bonded PTFE faced silicone liner that provides access with a syringe
- Pre-slit PTFE silicone liner easily pierced by liquid handling needles
- Can withstand autoclaving / sterilization



**Black Phenolic
Solid Top Cap**



**White Polypropylene
Open Top Cap**

Cat. No.	Cap Size	Cap Style	Cap Material	Color	Cap Liner	Qty / Pack	Qty / Case
W240820	13-425	Solid Top	Phenolic	Black	PTFE/14B Rubber	250	250
W240821	13-425	Solid Top	Phenolic	Black	PTFE/14B Rubber	250	1000
W240830	13-425	Solid Top	Polypropylene	White	Bonded PTFE/Silicone	250	250
W240831	13-425	Solid Top	Polypropylene	White	Bonded PTFE/Silicone	250	1000
W242710	13-425	Open Top	Polypropylene	Black	Bonded PTFE/Silicone	250	250
W240840	13-425	Open Top	Polypropylene	White	Bonded PTFE/Silicone	250	250
W240841	13-425	Open Top	Polypropylene	White	Bonded PTFE/Silicone	250	1000
W240848	13-425	Open Top	Polypropylene	Black	Pre-Slit Bonded PTFE/Silicone	250	250
W240849	13-425	Open Top	Polypropylene	Black	Pre-Slit Bonded PTFE/Silicone	250	1000
W240822	15-425	Solid Top	Phenolic	Black	PTFE/14B Rubber	250	250
W240823	15-425	Solid Top	Phenolic	Black	PTFE/14B Rubber	250	1000
W240832	15-425	Solid Top	Polypropylene	White	Bonded PTFE/Silicone	250	250
W240833	15-425	Solid Top	Polypropylene	White	Bonded PTFE/Silicone	250	1000
W240842	15-425	Open Top	Polypropylene	White	Bonded PTFE/Silicone	250	250
W240843	15-425	Open Top	Polypropylene	White	Bonded PTFE/Silicone	250	1000
W240850	15-425	Open Top	Polypropylene	Black	Pre-Slit Bonded PTFE/Silicone	250	250
W240851	15-425	Open Top	Polypropylene	Black	Pre-Slit Bonded PTFE/Silicone	250	1000
W240824	22-400	Solid Top	Phenolic	Black	PTFE/14B Rubber	100	100
W240825	22-400	Solid Top	Phenolic	Black	PTFE/14B Rubber	100	500
W240834	22-400	Solid Top	Polypropylene	White	Bonded PTFE/Silicone	100	100
W240835	22-400	Solid Top	Polypropylene	White	Bonded PTFE/Silicone	100	500
W240844	22-400	Open Top	Polypropylene	White	Bonded PTFE/Silicone	100	100
W240845	22-400	Open Top	Polypropylene	White	Bonded PTFE/Silicone	100	500
240418	24-400	Solid Top	Phenolic	Black	PTFE/14B Rubber	100	100
W240827	24-400	Solid Top	Phenolic	Black	PTFE/14B Rubber	100	500
W240836	24-400	Solid Top	Polypropylene	White	Bonded PTFE/Silicone	100	100
W240837	24-400	Solid Top	Polypropylene	White	Bonded PTFE/Silicone	100	500
W240846	24-400	Open Top	Polypropylene	White	Bonded PTFE/Silicone	100	100
W240847	24-400	Open Top	Polypropylene	White	Bonded PTFE/Silicone	100	500

Sample® Vials

- Select from glass or HDPE
- Glass vials made from WHEATON 180 low potassium borosilicate glass that conforms to ASTM E 438 Type I, Class A and USP Type I requirements
- Background counts are consistent and low in glass vials; ultraviolet transmission is high
- HDPE vials are economical choice for scintillation counting
- Caps packaged separately
- For additional organization of your vials use the WHEATON Vial Rack 868810



Glass HDPE

Cat. No.	Size (mL)	Cap Material	Liner Material	Cap Size	Dia. x H (mm)	Qty/ Case
Glass						
986491	6	Urea	Metal Foil / Pulp	13-425	17 x 58	1000
986492	6	Urea	Metal Foil / Pulp	15-425	17 x 58	1000
HDPE						
986644	6	Polypropylene	Linerless	18mm	17 x 57	1000
986645	6	Polypropylene	Linerless	18mm	17 x 57	2000

Culture Vial

- Culture vials feature deep-skirted screw caps to allow safer, more dependable handling when working with infectious materials
- Vials are manufactured from WHEATON 33 low extractable borosilicate glass that conforms to USP Type I and ASTM E 438 Type I, Class A requirements
- Pre-attached deep skirted solid-top black phenolic screw cap with 14B rubber liner
- Autoclavable
- Vials packaged in corrugated trays with partitions
- Use M-T Vial File® (Cat. No. 228780) for storing 4mL vials and (Cat. No. W228790) for storing 8mL vials



Cat. No.	Size (mL)	*Dia. x H (mm)	Cap Size	Qty / Case
225142	4	15 x 51	13-415	144
225144	8	17 x 70	15-415	144
225145	12	19 x 72	15-415	144

*Measurement taken with cap attached.

Omni-Vial®, Polypropylene

- 4mL polypropylene vial for wide variety of lab applications
- Press-fit cap made from polypropylene
- Vials and caps are packed separately in two polybags containing 500 each
- Vial can be autoclaved for 15 minutes at 121°C at 15 psi



Cat. No.	Size (mL)	Vial & Cap Material	Liner Material	Dia. x H (mm)	Qty / Case
225402	4	Polypropylene	Linerless	13 x 57	500

EPA Vial, 40mL

- Ideal for use in water sampling according to EPA 40 CFR 136, "Guidelines for Establishing Test Procedures for the Analysis of Pollutants"
- Clear vials manufactured from WHEATON 33 low extractable borosilicate glass that conforms to USP Type I and ASTM E 438 Type I, Class A requirements
- Amber vials manufactured from WHEATON 320 amber glass that conforms to USP Type I requirements for light transmission to protect light-sensitive products
- PTFE faced silicone lined caps attached to vials
- Vials packaged in convenient trays for ease of use

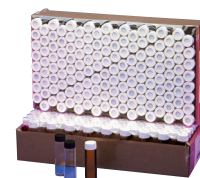

Cat. No.	Size (mL)	Size (dr)	*Dia. x H (mm)	Cap Size	Qty / Case
----------	-----------	-----------	----------------	----------	------------

Clear Vial with Open Top Black Phenolic Cap

225310	40	10	28 x 98	24-400	72
--------	----	----	---------	--------	----

Amber Vial with Open Top White Polypropylene Cap

225315	40	10	28 x 98	24-400	72
--------	----	----	---------	--------	----

*Measurement taken with cap attached.

Replacement Screw Caps & Septa

Cat. No.	Description	Cap Size	Qty / Case
W240518	Black Phenolic Open Top Screw Cap w/o Septa	24-400	200
W224600	White Glass-Filled Open Top Polypropylene Cap with Bonded 5 mils PTFE / 120 mils Silicone Septa	24-400	200

Dilution Vial

- Vial is marked with a blue line at the 3mL level
- Vials are manufactured from WHEATON 33 low extractable borosilicate glass that conforms to USP Type I and ASTM E 438 Type I, Class A requirements
- Pre-attached solid-top black phenolic screw cap with 14B rubber liner
- Autoclavable
- Vials are packaged in corrugated trays with partitions
- Use M-T Vial File® (Cat. No. 228780) for storing vials



Cat. No.	Size (mL)	*Dia. x H (mm)	Cap Size	Qty / Case
225002	4	15 x 48	13-425	144

*Measurement taken with cap attached.

Vials for Environmental Analysis

- Provided with open top white polypropylene PTFE faced silicone lined cap
- Septa of 5 mils of PTFE facing 120 mils of silicone is bonded to cap



Cat. No.	Size (mL)	Size (dr)	Dia. x H (mm) (cap on)	Cap Size	Qty / Case
----------	-----------	-----------	------------------------	----------	------------

Clear

W224609	20	5	28 x 60	24-400	72
W224610	25	6.25	28 x 73	24-400	72
W241503	40	10	28 x 98	24-400	72

Amber

W224612	20	5	28 x 60	24-400	72
W224614	40	10	28 x 98	24-400	72

Tamper Evident Safety Cap



- For use with Uni-Dose® Bottles and Vials
- Caps have Pulp / PVDC / PE Liner

Cat. No.	Description	For Mouth OD (mm)	Qty / Case
W224198	Cap for Uni-Dose® Bottle and Vial	28.5	2500
W224199	Cap with "For Oral Use" Imprint	28.5	5000
224316	Crimper	28.5	1

Uni-Dose® Bottle & Vial



- Available in amber glass or amber PET (Polyethylene Terephthalate)
- Mouth OD 28.5mm for Oral Dosing
- Use with WHEATON tamper evident safety cap
- Large labeling surface for easy product identification
- Manufactured from WHEATON 900 soda-lime amber glass that conforms to USP Type III requirements
- Safer alternative to glass and cost less to ship
- Use the 224316 Crimper to secure the tamper-evident safety caps (Cat. No. W224198 or W224199) to the bottle or vial

Cat. No.	Size (mL)	Dia. x H (mm)	Trays/Case	Qty / Case
Amber Glass Bottle				
226732	15	32 x 42	5	500
226733	30	36 x 58	5	500
Amber PET Vial				
226773	30	34 x 55	—	300





Battery Powered Crimping Tool

- Powerful motor with a fast cycle
- Convenient controls on top of unit to adjust crimp
- Long lasting battery with Lithium Ion technology - up to 800 crimps per charge
- Advanced charging system including warning light when recharging is necessary
- Can be operated while charging
- Optional base and mounting kit

Cat. No.	Description	Size (mm)	Qty
W225708	Battery Powered Crimper	8	1
W225711	Battery Powered Crimper	11	1
W225712	Battery Powered Decapper	11	1
W225713	Battery Powered Crimper	13	1
W225714	Battery Powered Decapper	13	1
W225720	Battery Powered Crimper	20	1
W225721	Battery Powered Decapper	20	1
W225715	Battery Powered Flip Cap Crimper	13	1
W225722	Battery Powered Flip Cap Crimper	20	1

Automatic Crimping Tool Stand

Cat. No.	Description	Qty
W225701	Crimping Tool Stand	1

High Performance Crimping Tool

- Fastest and most powerful WHEATON crimping tool
- Strong enough for all steel and magnetic caps
- Designed with external power source and cord (no battery)
- Uses interchangeable jaw sets
- Stores up to 9 programs for different caps and seals
- Optional base and mounting kit

Cat. No.	Jaw(s) Included	Size (mm)	Qty
W225730-[]	—	—	1
W225731-[]	Crimper	20	1
W225732-[]	Crimper & Decapper	20	1
W225733-[]	Flip Cap Crimper & Decapper	20	1

High Performance Jaw Sets

Cat. No.	Jaw Type	Size (mm)	Qty
W225741	Crimper Jaw Set	8	1
W225751	Crimper Jaw Set	11	1
W225752	Decapper Jaw Set	11	1
W225761	Crimper Jaw Set	13	1
W225762	Decapper Jaw Set	13	1
W225763	Flip Cap Crimper Jaw Set	13	1
W225771	Crimper Jaw Set	20	1
W225772	Decapper Jaw Set	20	1
W225773	Flip Cap Crimper Jaw Set	20	1

	Plug Style
[A]	North American Cord, 120V
[B]	Japan Cord, 100V
[C]	Europe Cord, 230V
[D]	UK Cord, 230V
[F]	Australia / China, 240V
[G]	Italy / Chile, 230V
[J]	India Cord, 230V

E-Z Crimper™

- Used to attach aluminum seals to bottles and vials with a crimp / serum finish
- Cushioned ergonomic handle reduces hand fatigue
- Labeled for quick size identification
- Polished crimping jaws provide consistent sealing



Cat. No.	Description	Qty / Case
W225300	Attaches 8mm Standard Aluminum Seals	1
W225301*	Attaches 11mm Standard Aluminum Seals	1
W225302	Attaches 13mm Standard Aluminum Seals	1
W225303	Attaches 20mm Standard Aluminum Seals	1

*The 11mm E-Z Crimper is supplied with a plunger insert to give the option of crimping the top of a vial creating an extra tight seal. We recommend this only for standard opening vials.

E-Z Decapper™

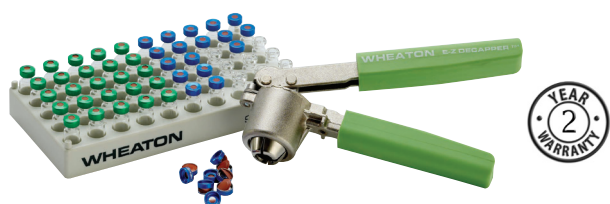

- Used to remove aluminum seals from bottles and vials with crimp / serum finish
- Cushioned ergonomic handle reduces hand fatigue
- Labeled for quick size identification
- Autoclavable

Cat. No.	Description	Qty / Case
W225350	Removes 8mm Standard Aluminum Seals	1
W225351	Removes 11mm Standard Aluminum Seals	1
W225352	Removes 13mm Standard Aluminum Seals	1
W225353	Removes 20mm Standard Aluminum Seals	1

Crimper / Decapper

- These crimpers are used for flip cap seals and for aluminum seals sizes 16.5, 28.5, and 30mm
- Not autoclavable



Cat. No.	Description	Qty / Case
224322	Crimper, attaches 13mm Flip Cap Seals	1
224321	Crimper, attaches 16.5mm Seals	1
224323	Crimper, attaches 20mm Flip Cap Seals	1
224316	Crimper, attaches 28.5mm Uni-Dose® Seals	1
224307	Crimper, attaches 30mm Seals	1
224357	Decapper, removes 30mm Seals	1

Plier Decapper

- An inexpensive and easy way to remove seals
- Made of steel with gray plastic-coated handles
- To remove a seal, simply secure the seal between the jaws, squeeze the handles and twist the seal



Cat. No.	Description	Qty / Case
224372	Removes 13mm Seals	1
224373	Removes 20mm Seals	1



Vial Racks



9.5mm Well ID
96-Position
985750



12.5mm Well ID
50-Position
985800



12.5mm Well ID
50-Position
W985810*



15.5mm Well ID
48-Position
868804



17.1 Well ID
90-Position
868810



23.1mm Well ID
36-Position
868805



28.1mm Well ID
50-Position
868806



30mm Well ID
50-Position
868808

- Manufactured from polypropylene
- Size of rack depends on vial OD
- Easy to clean and autoclavable
- Alphanumeric indexing indicated on rack
- The racks are sturdy and stackable, even when the vials are in place
- Each well has an opening in the bottom to facilitate drainage

When selecting the proper rack, the vial OD can not exceed the well ID dimension.

Cat. No.	Well ID (mm)	Description	No. of Wells	Dimensions (L x W x H)	Qty / Case
Polypropylene Rack					
985750	9.5	96-Position Rack	8 deep x 12 wide	18.5 x 12.5 x 2.2cm	5
985800	12.5	50-Position Rack	5 deep x 10 wide	19 x 10 x 2.2cm	5
W985810*	12.5*	50-Position Rack	5 deep x 10 wide	19 x 10 x 2.2cm	5
868804	15.5	48-Position Rack	4 deep x 12 wide	26.6 x 9.4 x 2.8cm	5
868810	17.1	90-Position Rack	6 deep x 15 wide	33 x 17 x 3cm	5
868805	23.1	36-Position Rack	3 deep x 12 wide	32.2 x 9.1 x 2.8cm	5
868806	28.1	50-Position Rack	5 deep x 10 wide	33 x 17 x 3cm	5
868808	30.0	50-Position Rack	5 deep x 10 wide	33.7 x 17 x 3cm	5

*This rack is specially designed for use with Freestanding CryoELITE® Cryogenic Vials. The vials lock in the rack for one-handed cap removal.

M-T Vial File®



228778



W228792 / 20mL

- Clear plastic hinged case for convenient storage and transportation of sample vials
- Polycoated partitions protect vials from abrasion and breakage
- Alphanumeric index card provides for easy vial identification
- Extra partitions and index cards can be purchased separately

Cat. No.	Description	Max Vial Size Dia. x H (mm)	Qty / Case
228778	Holds 60 – 2mL Vials	12 x 49	6
228780	Holds 40 – 4mL Vials	16 x 49	6
W228790	Holds 54 – 8mL Vials	18 x 64	6
W228792	Holds 24 – 20mL Vials	30 x 64	6

Replacement Partitions and Index Cards for M-T Vial Files®

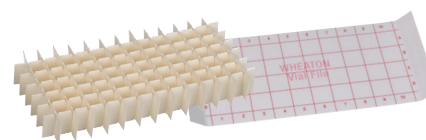

Partition

Index Card

Cat. No.	Description	Qty / Case
W228781	Partitions for Use with 228778	6
W228782	Partitions for Use with 228780	6
W228786	Partitions for Use with W228790	6
W228788	Partitions for Use with W228792	6
228783	Index Cards for Use with 228778	35
228785	Index Cards for Use with 228780	35
W228787	Index Cards for Use with W228790	35
W228789	Index Cards for Use with W228792	35



WHEATON



The WHEATON CryoELITE® Tissue Vial is for those who value sample integrity, designed specifically for tissue collection, transport and storage to provide the utmost protection. Different from cells and biofluids, tissue specimens have particular requirements for cryogenic storage. Offering researchers a uniform vial able to maintain sample integrity while maximizing storage capacity and organization, the CryoELITE Tissue Vials feature a wide-mouth opening, 5mL capacity and high integrity closure. The CryoELITE Tissue Vial offers researchers who work with tissue samples ease of use, convenience and security.

The CryoELITE Tissue Vials are manufactured from low binding, cryogenic-grade virgin polypropylene that meets the USP Class VI classification. Lot tested and certified to be free of pyrogens, RNase / DNase and endotoxins, the vials have a sample capacity of 5mL and a storage temperature range of -156°C to 121°C. The externally threaded cap provides a seal that exceeds DOT and IATA classifications for diagnostic specimens and their transport and is capable of maintaining a secure closure during freeze/thaw procedures. The vials have a flat bottom and a stippled external surface to promote easier handling.

The CryoELITE Tissue Vial is for those who value sample integrity, designed specifically for tissue collection, transport and storage to provide the ultimate protection. When your decision depends on sample integrity...Trust that specimen to a WHEATON CryoELITE Tissue Vial.



CryoELITE® Tissue Vial

- Lot certified RNase/DNase and Endotoxin Free providing assurance of product integrity
- Unrivaled cap seal exceeds DOT and IATA regulations ensuring ultimate protection of samples during transportation and demanding freeze-thaw handling
- Wide mouth for insertion and removal of tissue with forceps
- 5mL volume for use with tissue sections
- Directional indicators to allow orientation of tissue within vial
- Bagged in packs of 25 vials

Cat. No.	Size (mL)	Color	Sterile	Dimensions Dia. x H (mm)	Depth (mm)	Qty/Case
W985100	5	White	Yes	22 x 24	18	250

CryoELITE® Cryogenic Vials

- Lot certified RNase / DNase and endotoxin free and non-pyrogenic providing assurance for sample integrity
- Unrivaled cap seal exceeds DOT and IATA regulations ensuring ultimate protection of samples during transportation and demanding freeze-thaw handling
- Made from low binding, cryogenic grade virgin polypropylene
- Screw cap can be easily removed with one hand

Freestanding

- Loctagon™ Vial Skirt provides stability in freestanding position and locks into CryoELITE® Benchmark Rack in order to provide easy open and close with one hand
- Colored caps allow for color coding projects along with WHEATON colored freezer and storage boxes
- Optional 2D Data Matrix Bar Code Insert provides unique identifier for traceability
- Bottom format allows unrestricted view of 2D bar code for convenient automated scanning

Round Bottom

- Exacting round bottom allows for up to 17,000 MAX RCF (xG)

Cat. No.	Size (mL)	Color	Writing Patch	Sterile	Dimensions Dia. x H (mm)	Qty / Case
CryoELITE® Vials, Freestanding, Internal Thread						
W985915	1.2	Natural	Yes	Yes	12 x 40	500
W985902	2	Natural	Yes	No	12 x 50	1000
W985903	2	Natural	No	No	12 x 50	1000
W985922	2	Natural	Yes	Yes	12 x 50	500
W985916	2	White	Yes	Yes	12 x 50	500
W985917	2	Red	Yes	Yes	12 x 50	500
W985918	2	Pink	Yes	Yes	12 x 50	500
W985919	2	Yellow	Yes	Yes	12 x 50	500
W985920	2	Green	Yes	Yes	12 x 50	500
W985921	2	Blue	Yes	Yes	12 x 50	500
W985923	3	Natural	Yes	Yes	12 x 63	500
W985924	4	Natural	Yes	Yes	12 x 77	500
W985925	5	Natural	Yes	Yes	12 x 91	500

CryoELITE® Vials, Freestanding, External Thread						
W985874	0.5	White	Yes	Yes	12 x 49	500
W985862	1.2	Natural	Yes	Yes	12 x 37	500
W985883	1.2	White	Yes	Yes	12 x 37	500
W985884	1.2	Red	Yes	Yes	12 x 37	500
W985885	1.2	Pink	Yes	Yes	12 x 37	500
W985886	1.2	Yellow	Yes	Yes	12 x 37	500
W985887	1.2	Green	Yes	Yes	12 x 37	500
W985888	1.2	Blue	Yes	Yes	12 x 37	500
W985852	2	Natural	Yes	No	12 x 49	1000
W985853	2	Natural	No	No	12 x 49	1000
W985872	2	Natural	Yes	Yes	12 x 49	500
W985863	2	White	Yes	Yes	12 x 49	500
W985864	2	Red	Yes	Yes	12 x 49	500
W985865	2	Pink	Yes	Yes	12 x 49	500
W985866	2	Yellow	Yes	Yes	12 x 49	500
W985867	2	Green	Yes	Yes	12 x 49	500
W985868	2	Blue	Yes	Yes	12 x 49	500
W985869	3	Natural	Yes	Yes	12 x 63	500
W985870	4	Natural	Yes	Yes	12 x 78	500
W985871	5	Natural	Yes	Yes	12 x 93	500

CryoELITE® Vials, Round Bottom, Internal Thread						
W985910	1.2	Natural	Yes	Yes	12 x 39	500
W985911	2	Natural	Yes	Yes	12 x 49	500
W985900	2	Natural	Yes	No	12 x 49	1000
W985901	2	Natural	No	No	12 x 49	1000
W985912	3	Natural	Yes	Yes	12 x 63	500
W985913	4	Natural	Yes	Yes	12 x 76	500
W985914	5	Natural	Yes	Yes	12 x 90	500

CryoELITE® Vials, Round Bottom, External Thread						
W985860	1.2	Natural	Yes	Yes	12 x 35	500
W985861	2	Natural	Yes	Yes	12 x 49	500
W985850	2	Natural	Yes	No	12 x 49	1000
W985851	2	Natural	No	No	12 x 49	1000

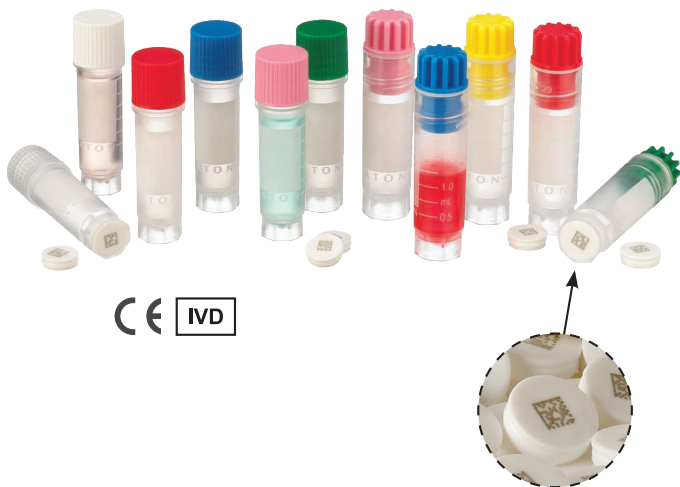

E-Z Microtube

- Polypropylene
- Uniquely numbered to ensure zero duplicated
- Fully traceable for perfect data management
- For storage down to -196°C
- Long lasting performance stability
- Supplied in a standard format 96-well rack with locking lid
- 1.0 and 1.4mL tubes supplied in standard twist-lock 96-well rack with locking lid

Cat. No.	Volume (mL)	Description	Qty / Case
W280110	0.5	E-Z Microtube, PP, 2D Barcode	10
W280121	1.0	E-Z Microtube, PP, 2D Barcode	10
W280135	1.4	E-Z Microtube, PP, 2D Barcode	10

CryoELITE® Cryogenic Vials Shelf Packs

- Packed in convenient smaller quantities
- 2 packs of 50 vials

Cat. No.	Size (mL)	Color	Writing Patch	Sterile	Dimensions Dia. x H (mm)	Qty / Case
CryoELITE® Vials, Freestanding, External Thread						
W985863-100 2	White	Yes	Yes	□	12 x 49	100
W985864-100 2	Red	Yes	Yes	■	12 x 49	100
W985865-100 2	Pink	Yes	Yes	■	12 x 49	100
W985866-100 2	Yellow	Yes	Yes	■	12 x 49	100
W985867-100 2	Green	Yes	Yes	■	12 x 49	100
W985868-100 2	Blue	Yes	Yes	■	12 x 49	100
W985872-100 2	Natural	Yes	Yes		12 x 49	100

CryoELITE® Cryogenic Vials, Pre-inserted Barcodes

- CryoELITE vials w/ 2D Data Matrix Barcode insert already applied

Cat. No.	Size (mL)	Color	Writing Patch	Sterile	Dimensions Dia. x H (mm)	Qty / Case
CryoELITE® Vials, Freestanding, External Thread						
W985863-BC 2	White	Yes	Yes	□	12 x 49	500
W985864-BC 2	Red	Yes	Yes	■	12 x 49	500
W985865-BC 2	Pink	Yes	Yes	■	12 x 49	500
W985866-BC 2	Yellow	Yes	Yes	■	12 x 49	500
W985867-BC 2	Green	Yes	Yes	■	12 x 49	500
W985868-BC 2	Blue	Yes	Yes	■	12 x 49	500

2D Data Matrix Bar Code Bottom Insert

- When purchasing WHEATON CryoELITE® freestanding vials, you can purchase an optional 2D Data Matrix Bar Code Insert that allows for immediate bar coding of your samples. The insert can also be applied to the vial at a future date, which eliminates jeopardizing the integrity of your sample by transferring it to another vial
- 2D Data Matrix Bar Code Insert press fits and locks into place in bottom of vial

Cat. No.	Description	Sterile	Shelf Pack	Qty / Case
W985881	2D Data Matrix Bar Code Bottom Insert	No	100	500

CryoELITE® Technical Information	
Material:	Made from low binding, cryogenic grade virgin polypropylene
Temperature Range:	-156°C to +121°C, tested to -196°C
Sterility:	Lot Certified Sterile, Radiation Sterilization
DNase & RNase Free:	Lot Certified, Ethidium Bromide (EtBr) Agarose Gel Electrophoresis Analysis
Non-Pyrogenic, Endotoxin Free:	Lot Certified < 0.500 EU/mL (Kinetic Turbidimetric LAL Method, FDA guideline)
Seal psi:	Exceeds 15 psi / 1 atmosphere / 95kPa pressure tested
IATA (International Air Transportation Association):	Can be used as a primary receptacle for the Transport of Diagnostic Specimens as outlined by the IATA Dangerous Goods Regulations, Part 6.3.5
DOT (U.S. Department of Transportation):	Exceeds U.S. DOT 49 CFR Parts 171-180 requirements for Diagnostic Specimen Packing and Transportation Requirements
Liquid Nitrogen:	Liquid phase tested / Vapor phase accepted
Autoclavable:	Recommended at +121°C, 15 psi (1 bar) for 20 minutes
Cap Pigmentation:	Cap colors were chosen to ensure no reactivity with common biological samples
2D Data Matrix Capacity:	Numeric 16 / Alphanumeric 10
2D Data Matrix Symbol Size:	Row x Column: 14 x 14
CE :	Product is CE compliant to The European <i>In Vitro</i> Diagnostic Medical Devices Directive 98/79/EC

KeepIT® Freezer Boxes



KeepIT®-25



KeepIT®-81 & 100

- KeepIT® Freezer Boxes provide an ideal method for batching and storing samples
- Six different colors match the colors of CryoELITE® Cryogenic Vials, creating alternatives for batching and identifying groups of samples
- KeepIT®-25 accommodates up to 25 internal or external threaded cryogenic Vial Sizes: 1.2 - 2mL
- KeepIT®-100 accommodates up to 100 internal threaded cryogenic vials and the KeepIT®-81 accommodates 81 external threaded cryogenic vials (sizes: 1.2 - 2mL)
- Openings in bottom facilitate scanning CryoELITE® 2D Data Matrix Bar Code Inserts
- Made from Eastman Tritan™ BPA free, shatter resistant resin
- Standard footprint compatible with liquid nitrogen storage shelves and freezer drawers

Cat. No.	Color	Dimensions (L x W x H) (mm)	Qty / Case
KeepIT®-25 For External Thread Vials			
W651702-W	White	75 x 75 x 52	10
W651702-R	Red	75 x 75 x 52	10
W651702-P	Pink	75 x 75 x 52	10
W651702-Y	Yellow	75 x 75 x 52	10
W651702-G	Green	75 x 75 x 52	10
W651702-B	Blue	75 x 75 x 52	10
Low Profile KeepIT®-81 For External Thread Vials			
W651703-W	White	130 x 130 x 52	10
W651703-R	Red	130 x 130 x 52	10
W651703-P	Pink	130 x 130 x 52	10
W651703-Y	Yellow	130 x 130 x 52	10
W651703-G	Green	130 x 130 x 52	10
W651703-B	Blue	130 x 130 x 52	10
Low Profile KeepIT®-100 For Internal Thread Vials			
W651704-W	White	130 x 130 x 52	10
W651704-R	Red	130 x 130 x 52	10
W651704-P	Pink	130 x 130 x 52	10
W651704-Y	Yellow	130 x 130 x 52	10
W651704-G	Green	130 x 130 x 52	10
W651704-B	Blue	130 x 130 x 52	10

CryoELITE® Benchmate Rack



- For use with both freestanding and round bottom vials
- One hand cap removal of freestanding vials
- Holds 50 cryogenic vials
- Manufactured from polypropylene
- Easily cleaned in an automatic washer or autoclavable at 121°C for 20 minutes
- Non-skid feet offer additional stability for bench work
- Stackable
- Well ID: 12.5mm
- Dimensions (L x W x H): (190 x 100 x 22mm)

Cat. No.	Description	No. of Wells	Qty / Case
W985810	50-Position Rack	5 deep x 10 wide	5

CryoFile® and CryoFile® XL Storage Boxes



- Use with cryogenic vials
- Partitions numbered from 1 – 81 for easy content identification
- Numbering system printed on lid and bottom of box
- Six colors provide easy sample identification
- Water repellent allows for longer durability
- For use with vapor phase of liquid nitrogen
- Directional holes in bottom allow for drainage and orientation of bottom to top of box
- Dimensions (L x W x H): CryoFile® (130 x 130 x 53mm) / CryoFile® XL (130 x 130 x 97mm) / CryoFile® Tissue Box (130 x 130 x 26mm)

Cat. No.	Fits	Color	Qty / Case
CryoFile® Storage Box			
W651600	1.2 & 2mL Vials	Green	15
W651601	1.2 & 2mL Vials	Yellow	15
W651602	1.2 & 2mL Vials	Pink	15
W651603	1.2 & 2mL Vials	White	15
W651604	1.2 & 2mL Vials	Blue	15
W651605	1.2 & 2mL Vials	Red	15
CryoFile® XL Storage Box			
W651600-XL	3, 4 & 5mL Vials	Green	15
W651601-XL	3, 4 & 5mL Vials	Yellow	15
W651602-XL	3, 4 & 5mL Vials	Pink	15
W651603-XL	3, 4 & 5mL Vials	White	15
W651604-XL	3, 4 & 5mL Vials	Blue	15
W651605-XL	3, 4 & 5mL Vials	Red	15
CryoFile® Tissue Storage Box (holds 25 Tissue Vials)			
W651610-G	5mL Tissue Vials	Green	15
W651610-Y	5mL Tissue Vials	Yellow	15
W651610-P	5mL Tissue Vials	Pink	15
W651610-W	5mL Tissue Vials	White	15
W651610-B	5mL Tissue Vials	Blue	15
W651610-R	5mL Tissue Vials	Red	15

FTA® Nucleic Acid Collection Storage box



- Storage boxes provide an ideal method for batching and storing FTA Nucleic Acid Collection pouches
- For use with small or large FTA cards
- Accommodates two rows of 3" FTA card pouches or one row of 6" FTA Card Pouches
- Removable divider for use with smaller pouches
- Water repellent box material allows for longer durability
- For use at RT, 4°C, -20°C or colder

Cat. No.	Dimensions (L x W x H) (in)	Qty / Case
W651611	18 x 6 x 4	2
W651612	18 x 7 x 4	2



SingleScan™ Bar Code Reader

- Plug and play design enables easy set up with no software installation required
- USB interface allows easy connection to computer
- Reads 1D linear bar codes and 2D Data Matrix bar codes on any vial or ampule
- Inputs decoded bar code ID into any software application where cursor is placed

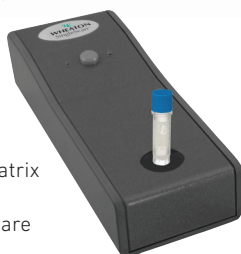

Cat. No.	Description	Qty
W986000	SingleScan™ Bar Code Reader	1

PluraScan™ Bar Code Reader

- 2D Data Matrix Bar Code Reader
- Works with WHEATON KeepIT® Boxes and WHEATON CryoELITE® Cryogenic Vials and Cryule® Ampules as well as WHEATON E-Z Microtubes
- Flexible software integration
- Integrated frost reduction system allows multiple racks to be read
- Capable of reading bar codes from wide range of manufacturers and label printers

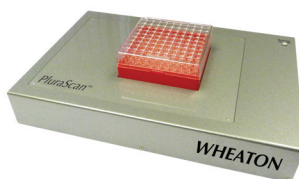

Cat. No.	Description	Qty
W986010	PluraScan™ Bar Code Reader	1

2D Data Matrix Bar Code Bottom Insert

- When purchasing WHEATON CryoELITE® freestanding vials, you can purchase an optional 2D Data Matrix Bar Code Insert that allows for immediate bar coding of your samples. The insert can also be applied to the vial at a future date, which eliminates jeopardizing the integrity of your sample by transferring it to another vial
- 2D Data Matrix Bar Code Insert press fits and locks into place in bottom of vial

Cat. No.	Description	Sterile	Qty / Case
W985881	2D Data Matrix Bar Code Bottom Insert	No	500

WHEATON Scanners Technical Information		
	SingleScan™	PluraScan™
Code Formats	1D Linear	—
	2D Data Matrix	✓
	ISO 16022	✓
	Square Rectangular Format	✓
	ECC 200	✓
	0-20 Grid Sizes	✓
	White on Black Black on White	✓
	Numeric	✓
	Alphanumeric	✓
Sensor Type	1.3 million pixel CMOS sensor	CCD Image Sensor
Light Source	Class 2M visible laser diode at 630nm	CCFL (Cold Cathode Fluorescent Light Source)
Dimensions (W x D x H)	61mm x 167mm x 41.2mm	75cm x 50cm x 30cm
Power	USB Hub (5V)	AC 100 to 240V, +10%/-10%, Less than 8W
User Interface	Keyboard Wedge	WHEATON GUI, including Windows® operating system TCP / IP, ODBC
Cable Interface	USB	USB2.0 USB 1.1 (B Type)
Operating System	Factory configured for Windows® operating systems compatibility. Also compatible with non-windows operating systems	Windows®7, 2000, XP
Ambient Operating Temperature	5 to 50°C	
Storage Temperature	-20 to 65°C	
Operating Humidity	(Non-condensing) 5 to 95°C	

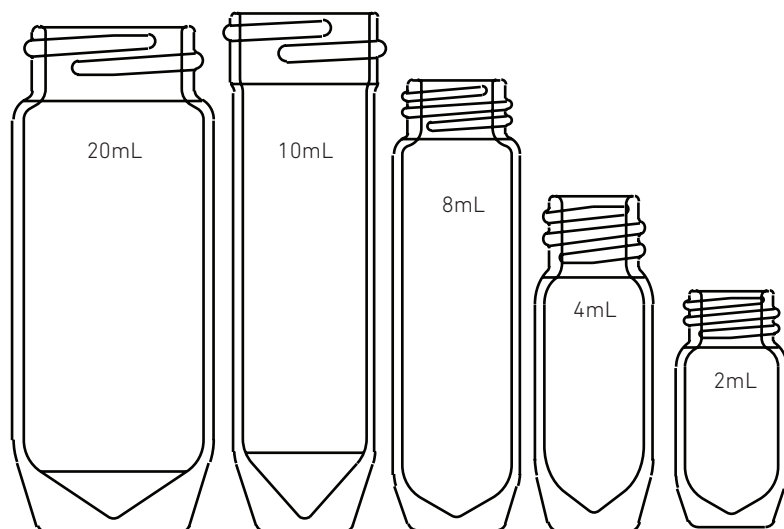
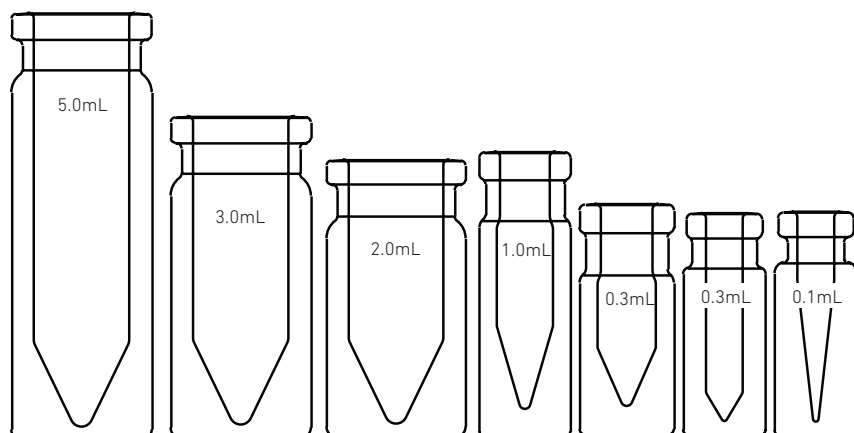
E-Z Ex-Traction® Vials (Approximate Size)**NextGen™ V Vials®** (Approximate Size)

Crimp / Serum Finish

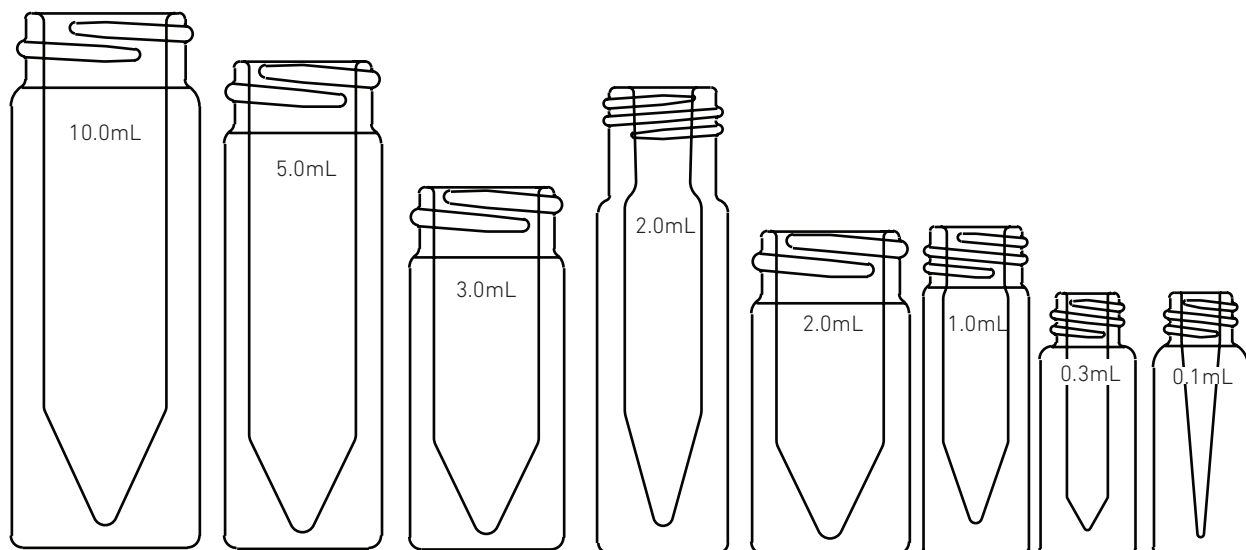

Screw Thread Vials

Serum Bottles and Vials (Approximate Size)



Serum Bottles

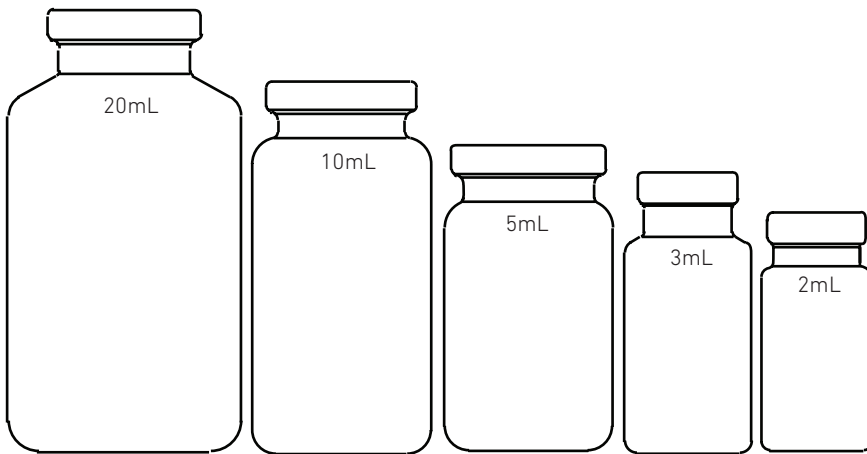

Serum Vial



WBRO_018 04/2018

DWK Life Sciences
1501 North 10th Street
Millville, NJ 08332
United States

US & Canada: 800.225.1437
Int'l: 856.825.1100
Fax: 856.825.1368
www.DWK-LifeSciences.com